

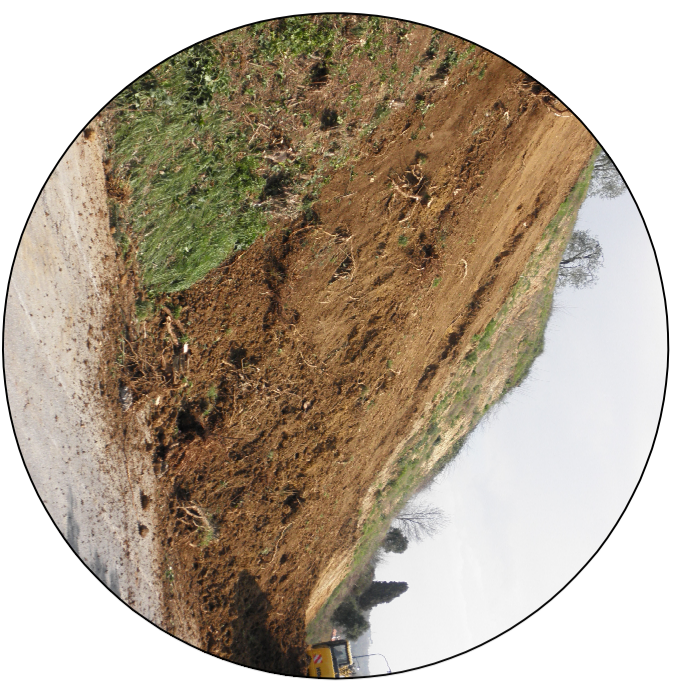

COMUNE DI SANTA MARIA A MONTE
Provincia di Pisa

**CONSOLIDAMENTO DI UN TRATTO DI
VERSANTE A MONTE DELLA VIA REPUBBLICA**

PROGETTO DEFINITIVO - ESECUTIVO	Data
SEZIONE E PARTICOLARI scala: VARIE	Luglio 2016
TAV. 16.01.D.E.S3 Sez e Part.	



Responsabile del Procedimento
Progettista e D.L.
Ing. Maurizio Iannotta

Progettista geologo e collaboratore
Geol. Alessandra Giannelli

Servizio L.P.P.
Comune di Santa Maria a Monte

Servizio L.P.P.
Comune di Santa Maria a Monte

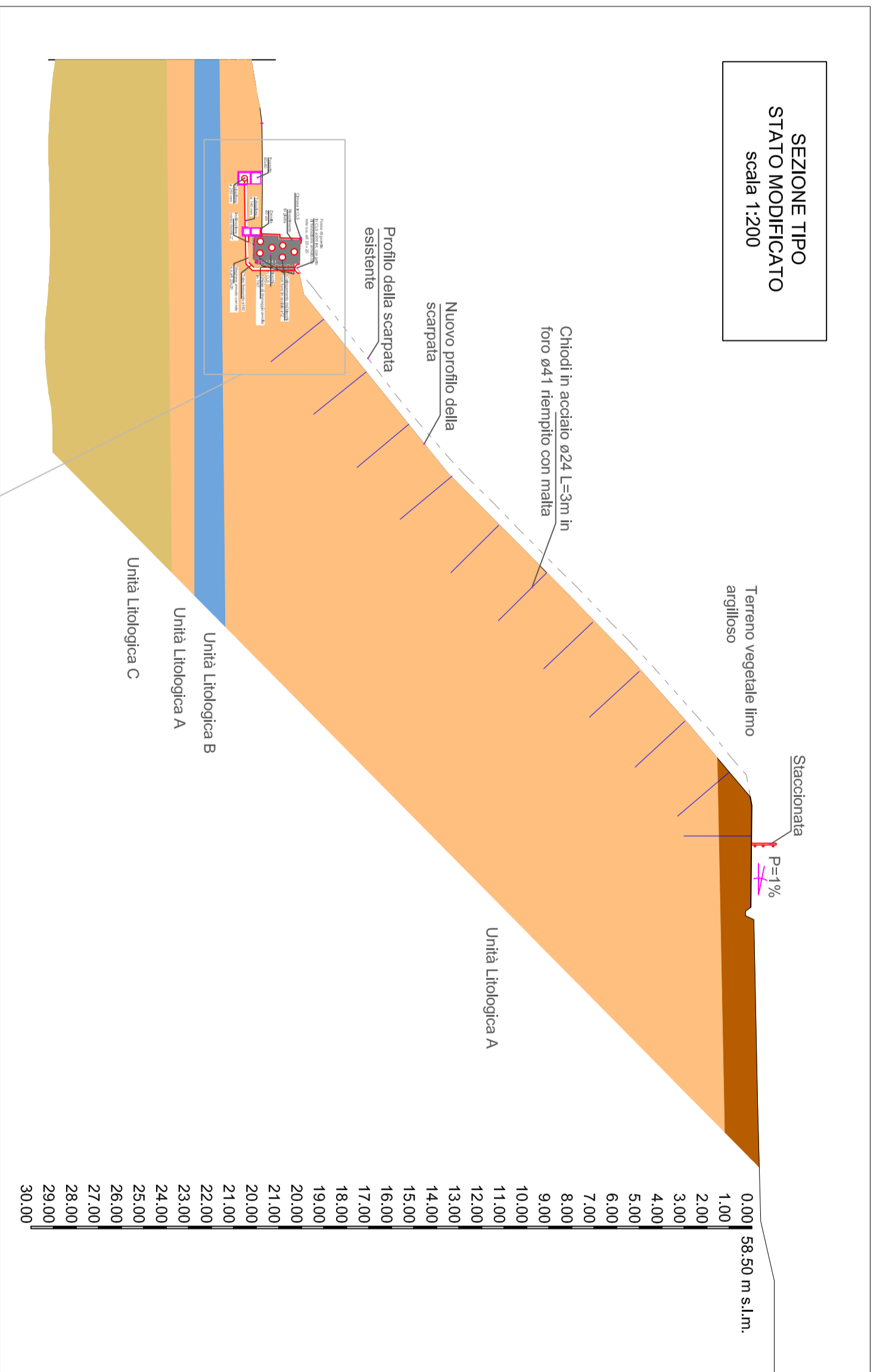
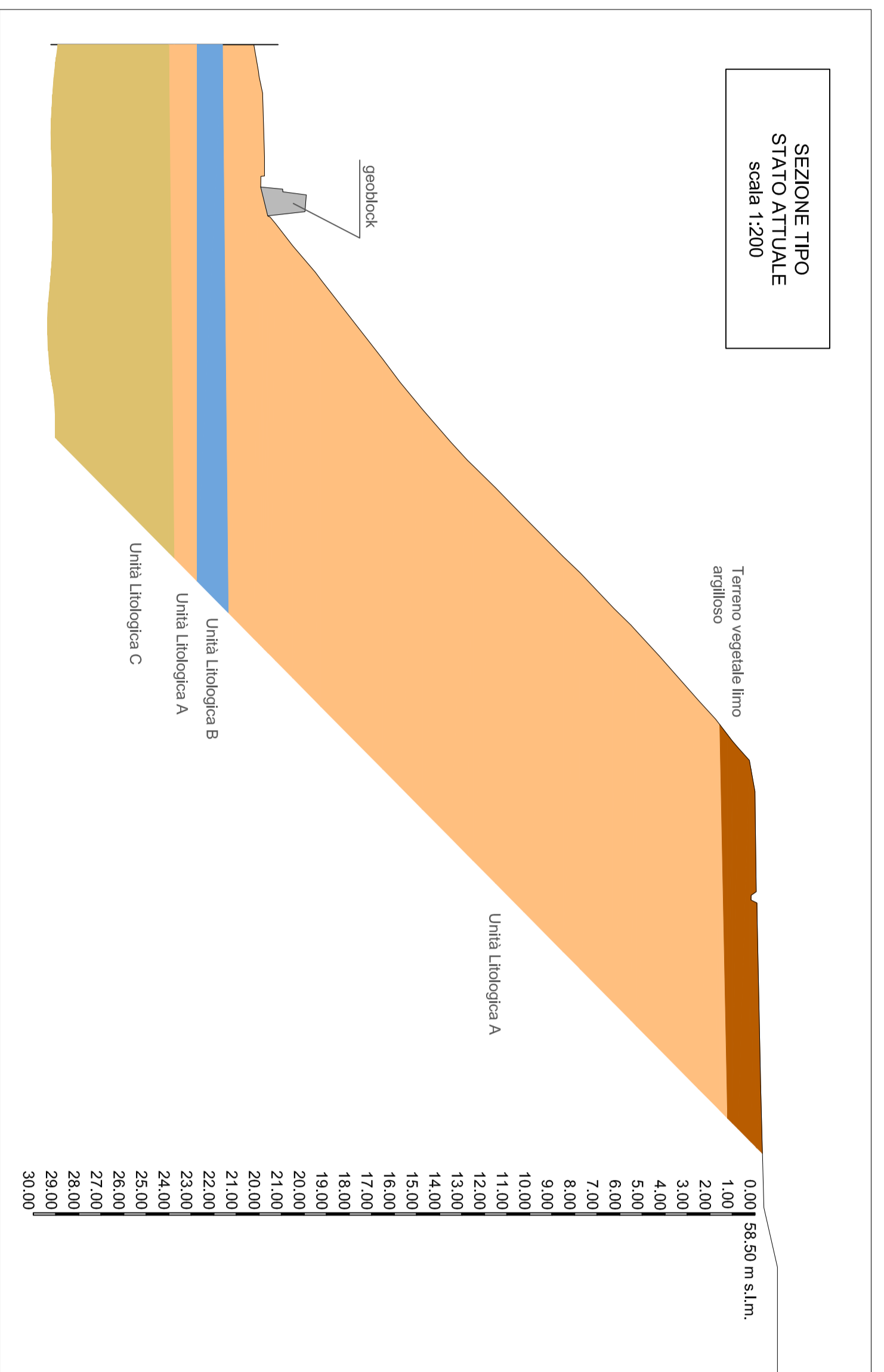

SETTORE 3 - UFFICIO LAVORI PUBBLICI

**PARTICOLARI DEL SISTEMA DI
PROTEZIONE DEL VERSANTE**

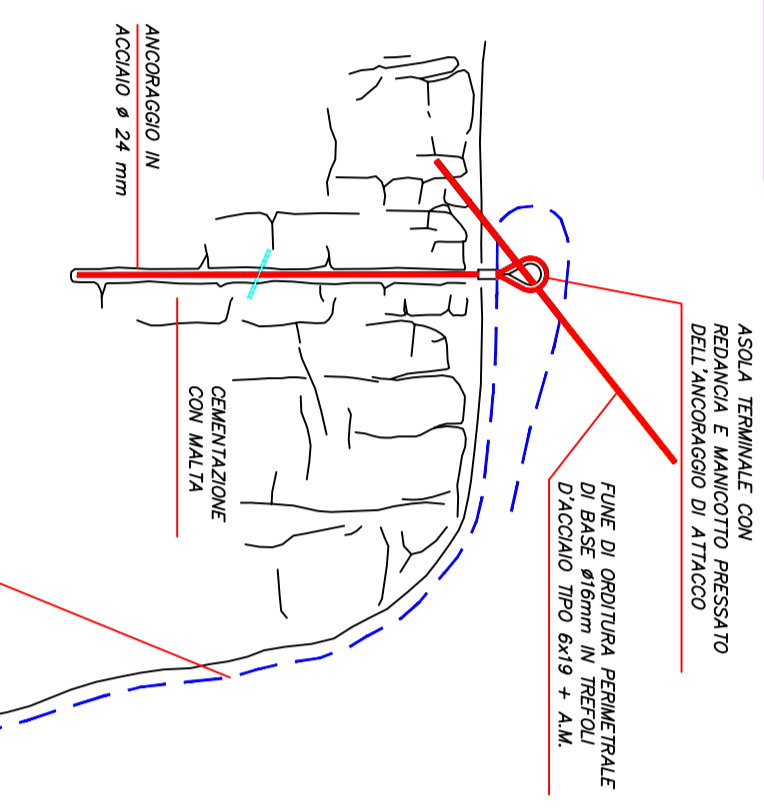
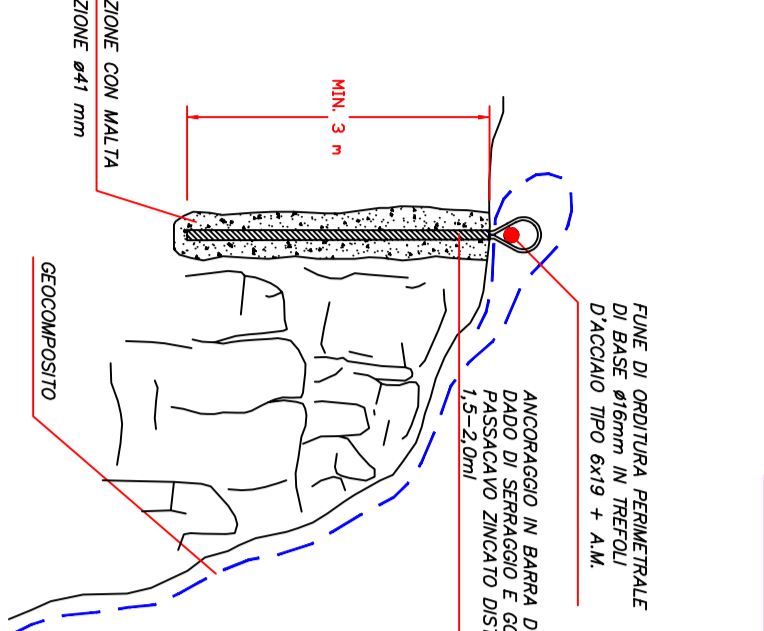
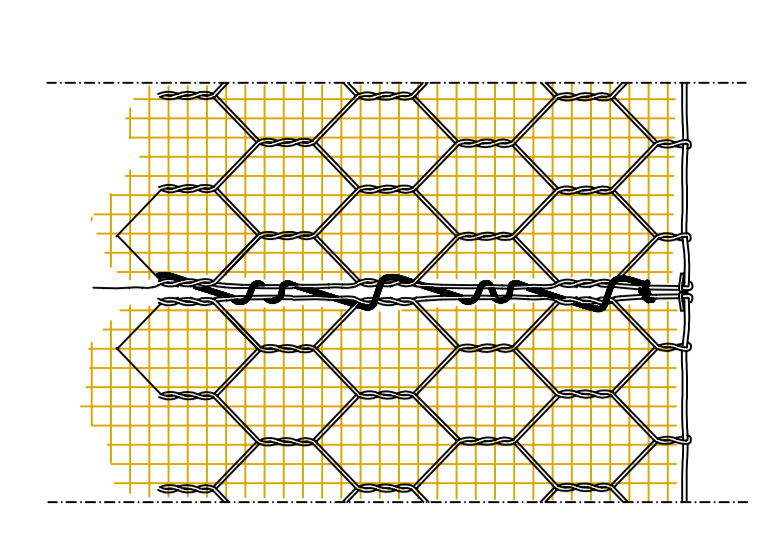

**PARTICOLARE DEL MURO IN GEOBLOC
SCALA 1: 25**

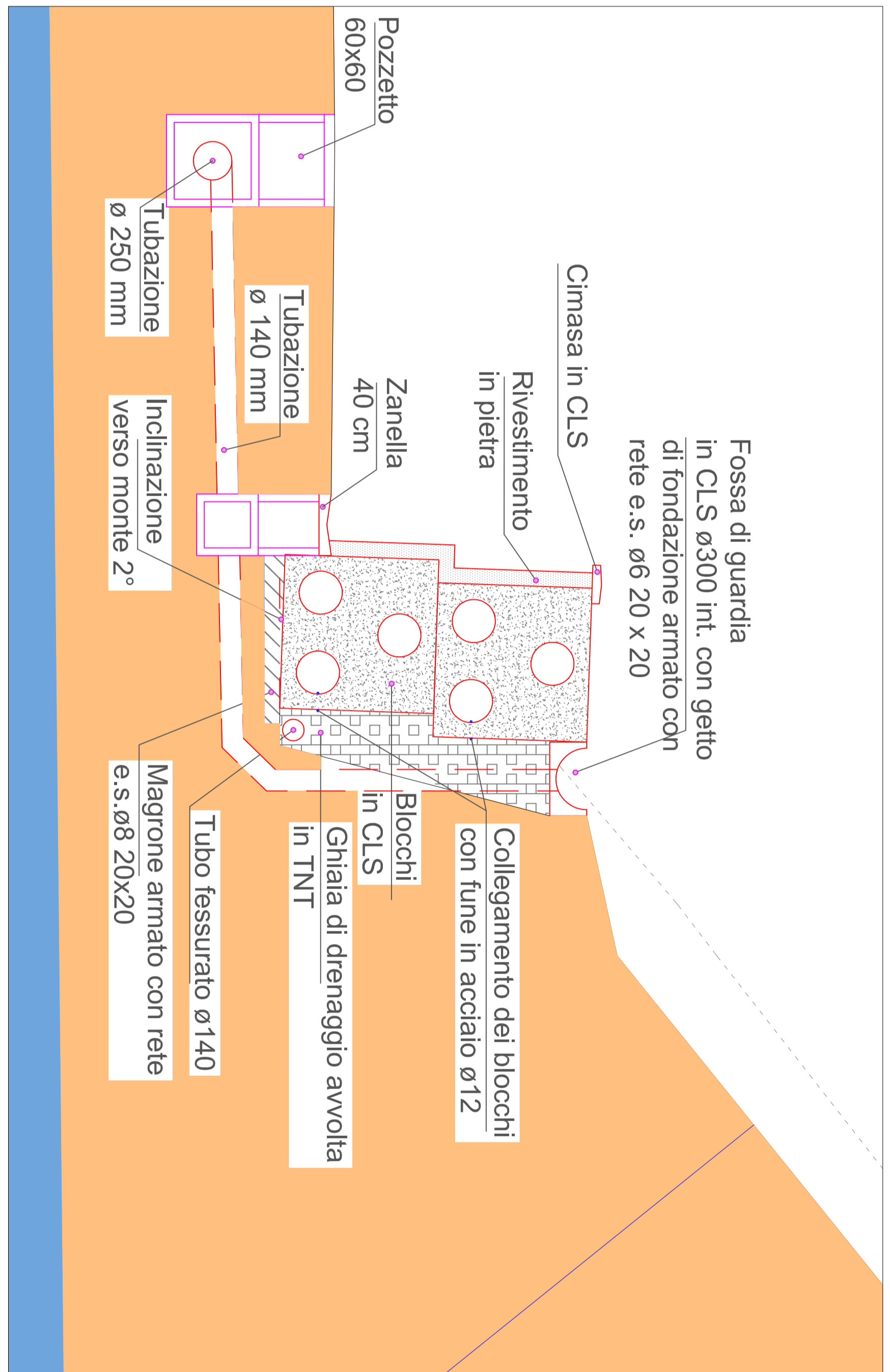

**PARTICOLARE SCAVO FOGNATURA
SCALA 1: 10**

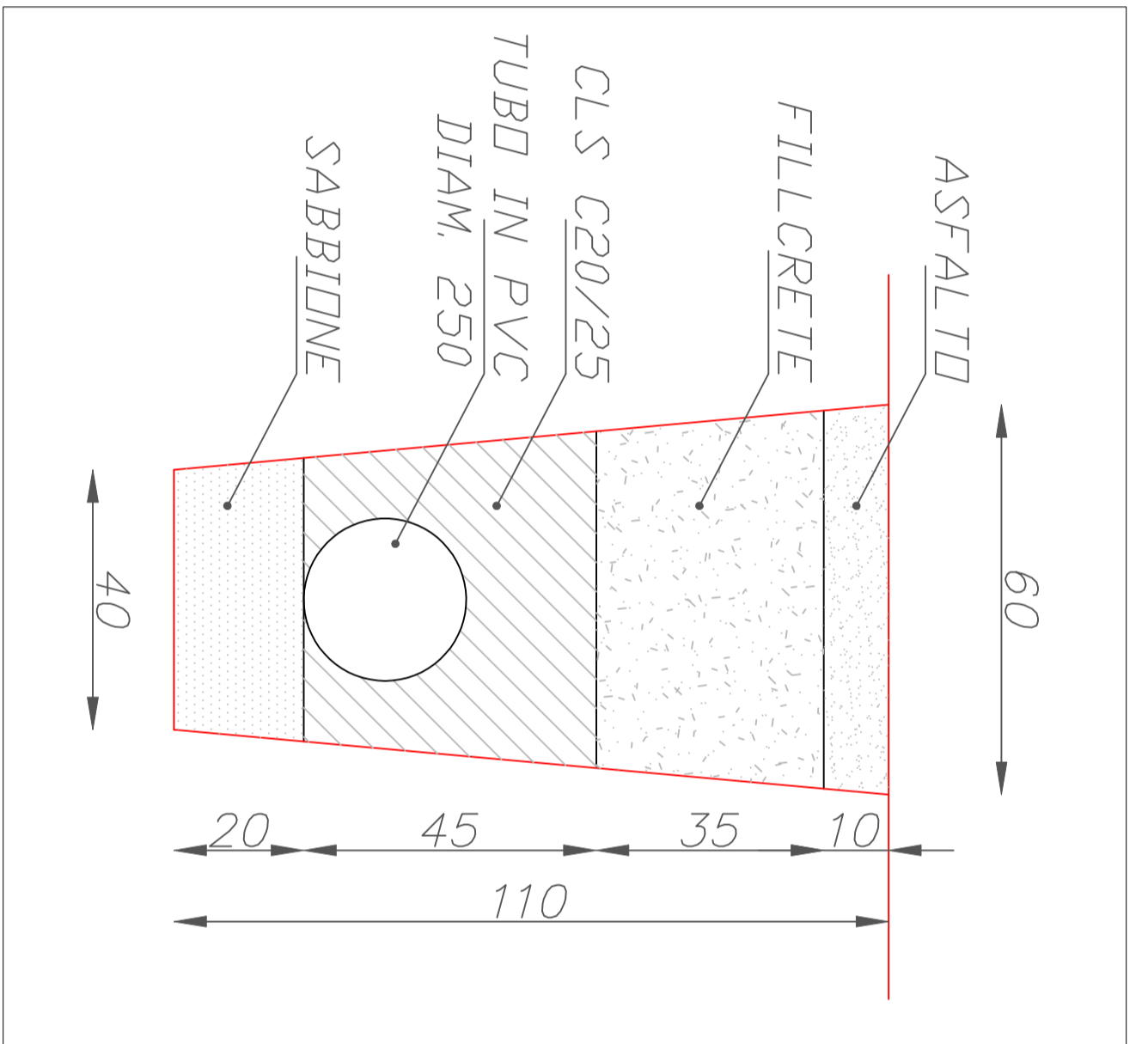

**PARTICOLARE CANALETTA IN C.A.
SCALA 1: 10**

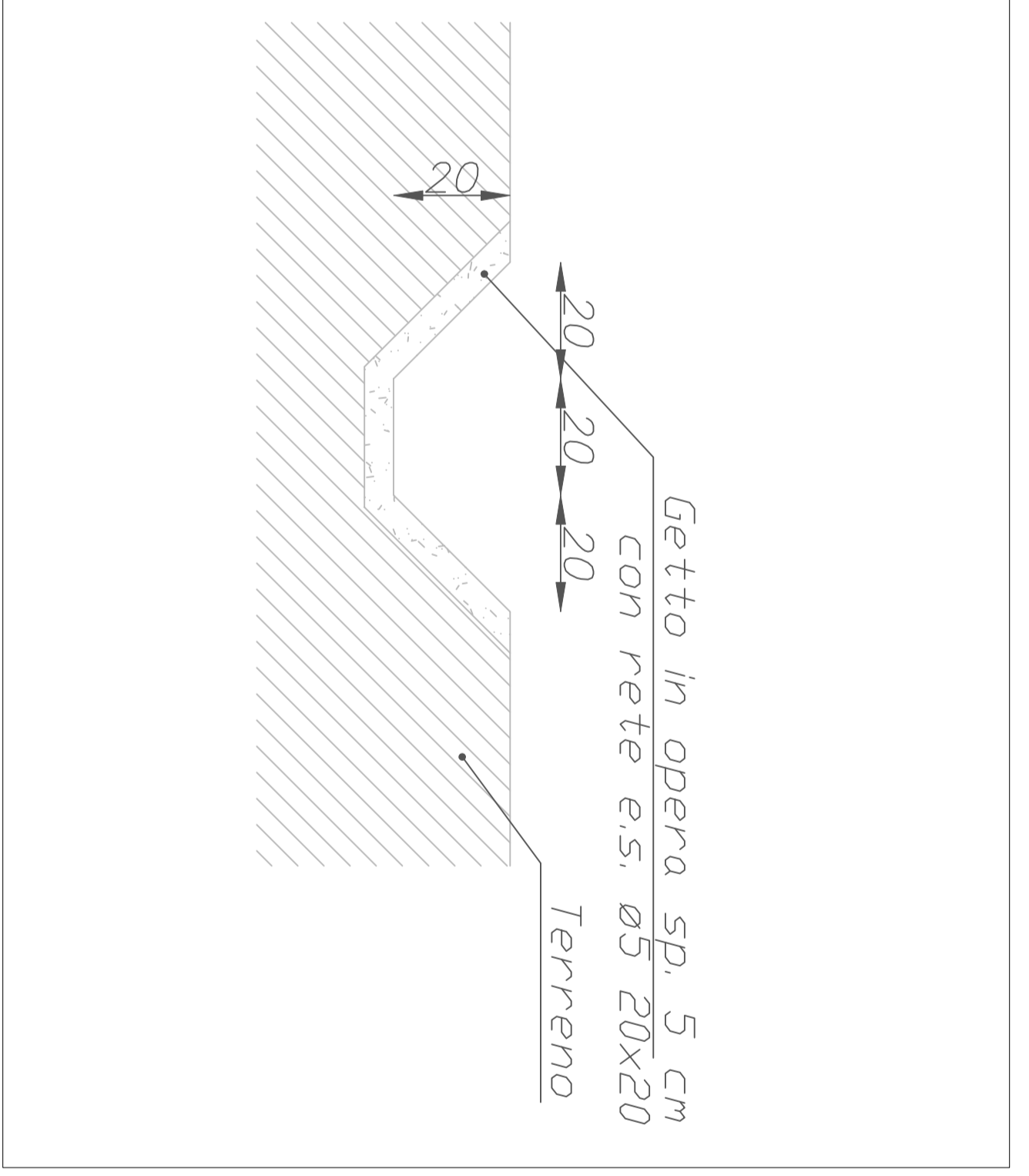

DETTAGLIO RISOLTO IN SOKMITZ.

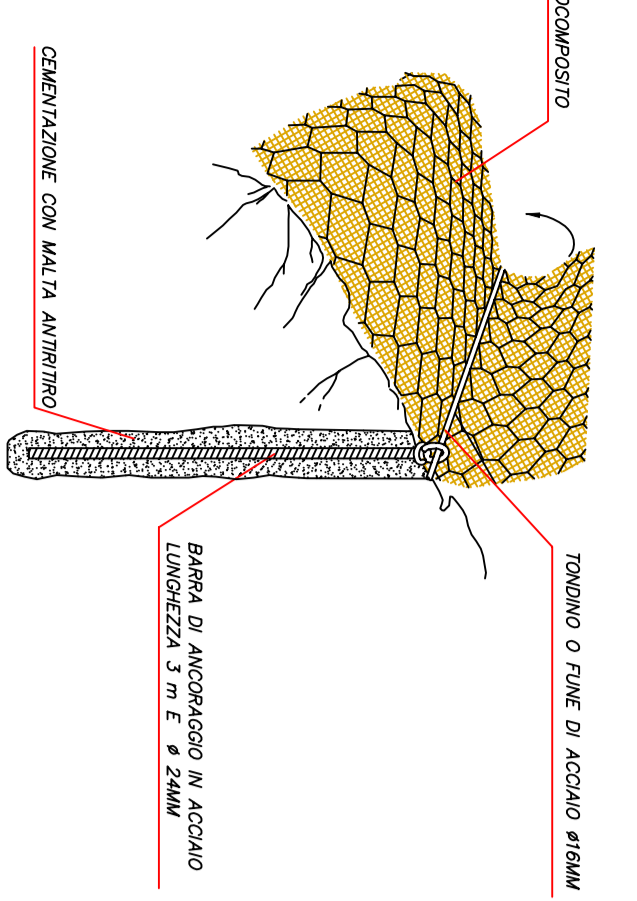

SISTEMI DI ANCORAGGIO IN PARETE

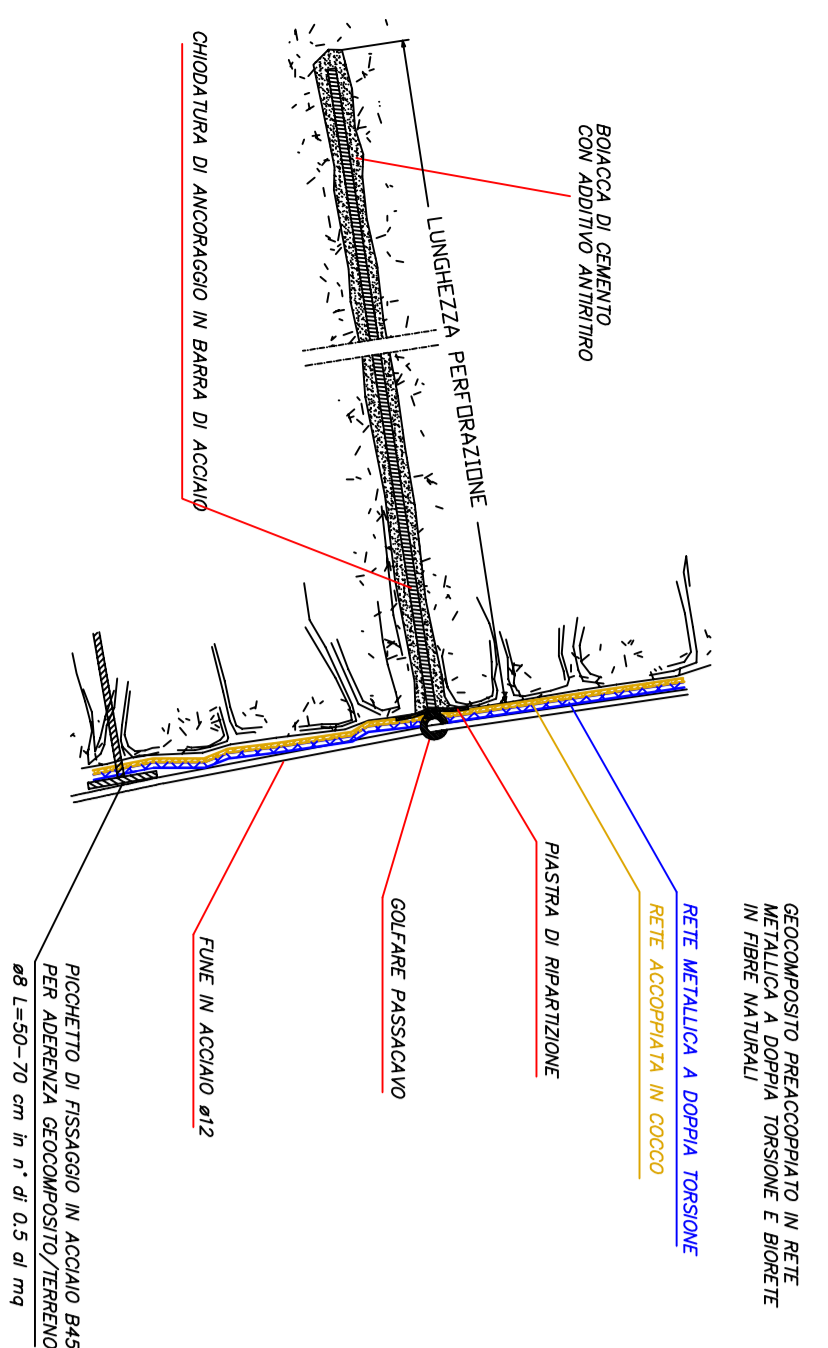

**SISTEMI DI RINFORZO CORTICALE ANTERIORE
CON FINIZIONE DI RINFORZO STRUTTURALE E RINNEBBAMENTO**

**ARMATURA IN TREPOLI DI ACCIAIO
CON MAGLIA QUADRATA 3x3**

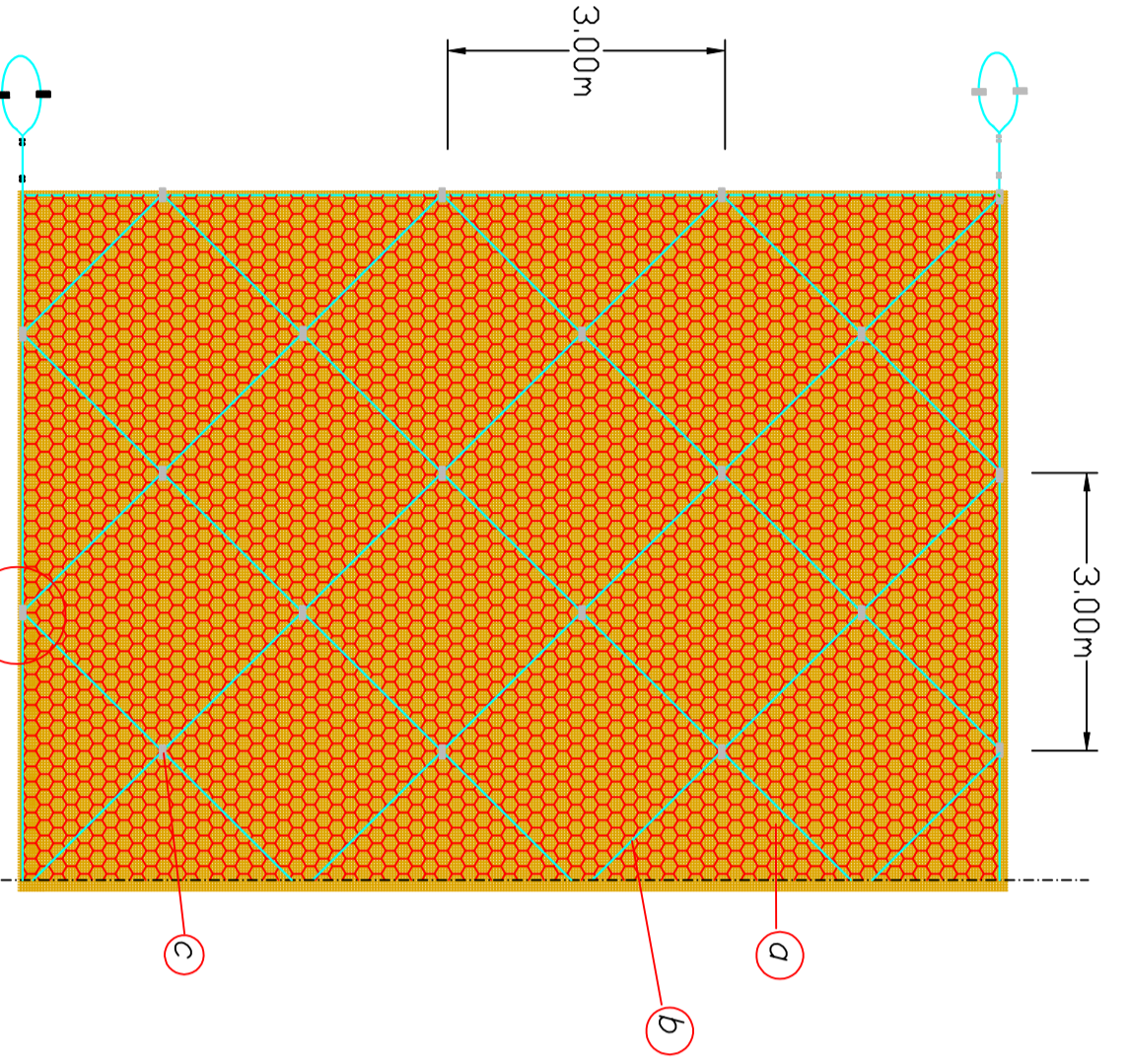

DIMENSIONI MASCHERATO

SPESSE (cm)	PERI. MASCH.	CONTENUTO (kg)
10	4x4	1,4
15	4x4	2,1
20	4x4	2,8

ARMATURA A CALDO

SISTEMA DI ANCORAGGIO AL PIEDE

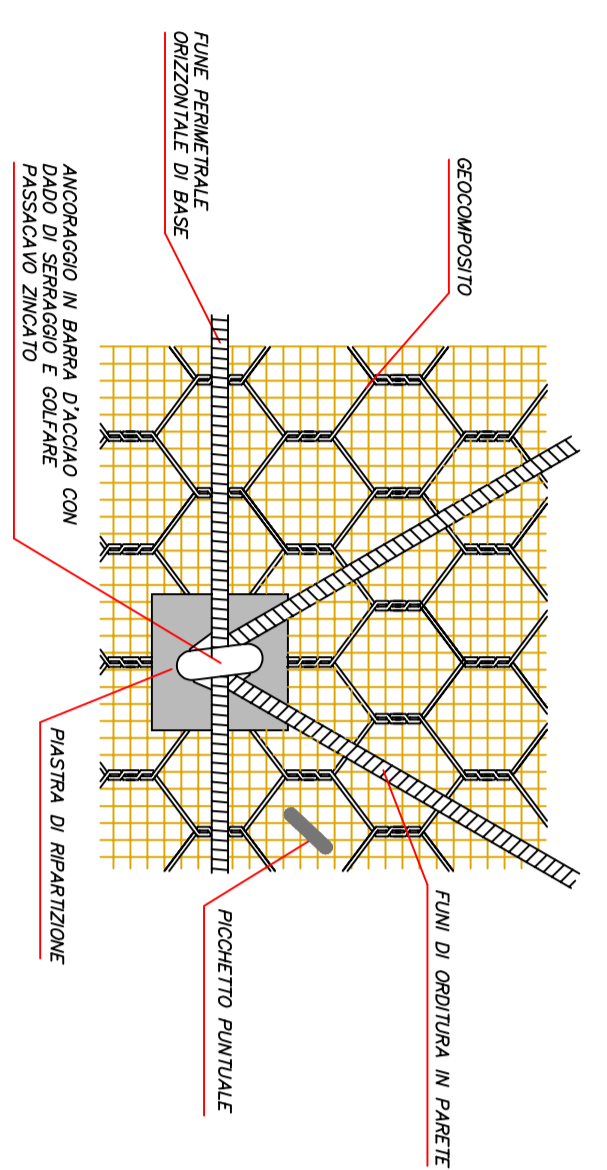

SISTEMA DI FISSAGGIO DELLA FINIS FINEMETRALE

